

DEHN SURGERY ON ARBORESCENT LINKS

YING-QING WU

ABSTRACT. This paper studies Dehn surgery on a large class of links, called arborescent links. It will be shown that if an arborescent link L is sufficiently complicated, in the sense that it is composed of at least 4 rational tangles $T(p_i/q_i)$ with all $q_i > 2$, and none of its length 2 tangles are of the form $T(1/2q_1, 1/2q_2)$, then all complete surgeries on L produce Haken manifolds.

The proof needs some result on surgery on knots in tangle spaces. Let $T(r/2s, p/2q) = (B, t_1 \cup t_2 \cup K)$ be a tangle with K a closed circle, and let $M = B - \text{Int}N(t_1 \cup t_2)$. We will show that if $s > 1$ and $p \not\equiv \pm 1 \pmod{2q}$, then ∂M remains incompressible after all nontrivial surgeries on K .

Two bridge links are a subclass of arborescent links. For such a link $L(p/q)$, most Dehn surgeries on it are non-Haken. However, it will be shown that all complete surgeries yield manifolds containing essential laminations, unless p/q has a partial fraction decomposition of the form $1/(r - 1/s)$, in which case it does admit non-laminar surgeries.

0. INTRODUCTION

In Dehn surgery theory, we would like to know what 3-manifolds are produced through certain surgeries on certain knots or links. More explicitly, we want to know how many surgeries yield Haken, hyperbolic, or laminar manifolds, and how many of them are “exceptional”, meaning that the resulting manifolds are reducible, or have cyclic or finite fundamental group, or are small Seifert fibered spaces. There have been many results on these problems for surgery on knots. See [Gor] and [Ga] for surveys and frontier problems.

These results, however, are not ready to be generalized to surgery on links of multiple components. The major difficulty is that surgery on one component of the link may change the property of the other components. An exception is Thurston’s hyperbolic surgery theorem [Th], which says that if L is a hyperbolic link, then except for finitely many slopes on each component of L , all other surgeries are hyperbolic. Another interesting result is Scharlemann’s simultaneous crossing change theorem, see [Sch].

There has been extensive study about surgery on a large class of knots called arborescent knots, also known as Conway’s algebraic knots [Co, BS], which include all Montesinos knots. The name “arborescent links” is first used by Gabai [Ga2]. A knot or link is arborescent if it can be built by summing rational tangles together. See Section 1 for more detailed definitions. In [Oe] Oertel showed that surgeries on Montesinos knots of length ≥ 4 produce Haken manifolds. In [De1, De2] Delman showed that surgeries on all non-torus 2-bridge knots and most Montesinos knots are laminar, that is, they contain essential laminations. See [GO] for the definition and basic properties of laminar manifolds. In [Wu2] it was shown that if K is

1991 *Mathematics Subject Classification*. Primary 57N10; Secondary 57M25, 57M50.

a non-Montesinos arborescent knot, then all surgeries are laminar. Moreover, in most cases the surgeries are Haken and hyperbolic. Also, surgeries on 2-bridge knots have been classified [BW], according to whether the resulting manifold is toroidal, Seifert fibered, or “hyperbolic” in the sense that it would be hyperbolic if the hyperbolization conjecture is true. These results provide satisfactory understanding of surgery on all arborescent knots, except certain Montesinos knots of length 3. In particular, all arborescent knots have Strong Property P [Wu2], that is, manifolds obtained by surgery on such knots do not contain a fake 3-ball.

Let $L = l_1 \cup \dots \cup l_n$ be a link of n components; let $\gamma = \gamma_1 \cup \dots \cup \gamma_n$, where γ_i is a slope on $\partial N(l_i)$. We use $L(\gamma)$ to denote the manifold obtained by γ surgery on L . More precisely, $L(\gamma)$ is obtained by gluing n solid tori V_1, \dots, V_n to $S^3 - \text{Int}N(L)$ along their boundary so that each γ_i bounds a meridional disk in V_i . If some γ_i is a meridian of l_i , then $L(\gamma)$ is the same as a surgery on a sub-link. We say that the γ surgery is a *complete surgery* if all γ_i are non-meridional slopes.

In [Oe] Oertel studied closed incompressible surfaces in the exteriors of Montesinos links L . He also showed that if L is a knot with length ≥ 4 and is composed of rational tangles $T(p_i/q_i)$ with $q_i \geq 3$, then nontrivial Dehn surgeries on L always produce Haken manifolds. Note, however, that this is not true in general if L is a Montesinos link, as demonstrated in Remark 0.1(b) below. We need an extra condition. The following is one of the main theorems of the paper. It says that if we further require that none of the length 2 tangles of L is of the form $T(1/2q_1, 1/2q_2)$, then all complete surgeries on L are Haken, and this is true even if L is an arborescent link. One is referred to section 1 for definitions of algebraic tangles, arborescent links, and their length.

Theorem 3.4. *Let $L = k_1 \cup \dots \cup k_n$ be an arborescent link of length ≥ 4 , so that (1) L is composed of rational tangles $T(p_i/q_i)$ with $q_i > 2$, and (2) no length 2 tangle of L is a Montesinos tangle of the form $T(1/2q_1, 1/2q_2)$ for some integers q_1, q_2 . Then all complete surgeries on L produce Haken manifolds.*

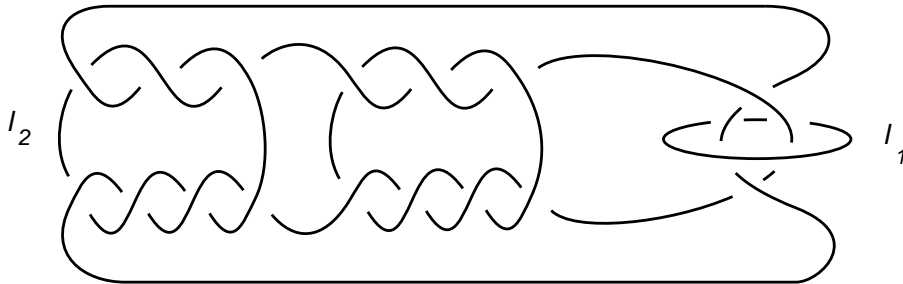

Figure 0.1

Remark 0.1. (a) Consider the link L in Figure 0.1. It is easy to see that L is an arborescent link of two components. Surgery on k_1 with coefficient $+1$ yields S^3 , in which k_2 is a trivial knot, so all surgeries on k_2 yields non-Haken manifolds. The example can be modified so that the length of L is arbitrarily large. It shows that condition (1) in the theorem is necessary. For another example one can take K to be a knot which is the union of two tangles $T(1/2, p_1/q_1)$ and $T(1/2, p_2/q_2)$. By choosing p_i/q_i properly K will satisfy condition (2) of the theorem, but it has been shown in [Wu2] that most integral surgeries on K are non-Haken.

(b) Consider the Montesinos link $L = L(1/2n_1, \dots, 1/2n_k)$. There is a non-separating planar surface P in S^3 with one boundary component on each component of L . Thus surgery along the boundary slope of P yields a reducible manifold. Therefore condition (2) in the theorem is necessary. However (2) can be removed if L has only two components.

Theorem 4.2. *Suppose $L = l_1 \cup l_2$ is an arborescent link of two components. If L has length at least 4, and none of the rational tangles used to build L is a $(1/2)$ -tangle, then all complete surgeries on L produce Haken manifolds.*

In section 5 we study surgeries on 2-bridge links. Since there are no closed essential surfaces in the complement of such links, most surgeries are non-Haken [Fl]. However, the following theorem shows that, like in the case of 2-bridge knots, surgeries on most 2-bridge links are laminar.

Theorem 5.1. *A non-torus 2-bridge link $L = L(p/q)$ admits complete, non-laminar surgeries if and only if $p/q = 1/(r - 1/s)$ for some odd integers r and s .*

This generalizes Delman's result about surgery on 2-bridge knots [De1]. The theorem is proved by applying Delman's construction of essential branched surfaces to certain "allowable paths" in the minimal diagram associated to p/q . It completely determines which 2-bridge link complements contain persistent laminations.

The paper is organized as follows. In Section 1 we give some definitions, and a few easy lemmas. Section 2 is to study Dehn surgeries on a closed circle component of a tangle. The following result should be of independent interest.

Theorem 2.7. *Let $T = T(r/2s, p/2q) = (B, t_1 \cup t_2 \cup K)$ be a tangle such that $s > 1$, and $p \not\equiv \pm 1 \pmod{2q}$. Let K be the closed component of T , and let $M = B - \text{Int}N(t_1 \cup t_2)$. Then ∂M is incompressible in $(M, K; \gamma)$ for all $\gamma \neq m$, where m is the meridional slope of K .*

This is used in Sections 3 and 4 to prove Theorems 3.4 and 4.2. Section 5 is to study essential laminations and surgery on 2-bridge links, and prove Theorem 5.1.

1. PRELIMINARIES

All 3-manifolds in this paper are assumed orientable and compact. We refer the reader to [He] for basic concepts about 3-manifolds. If X is a subset of a 3-manifold M , we use $N(X)$ to denote a regular neighborhood of X , and use $|X|$ to denote the number of components in X .

For our purpose, we define a *tangle* to be a pair (B, T) , where B is a 3-ball, and T is a properly embedded 1-manifold, containing two strings t_1, t_2 and some circles. We use $E(T)$ to denote the *tangle space* $B - \text{Int}N(T)$. If T is properly isotopic to a pair of arcs on ∂B then (B, T) is called a *trivial tangle*. A *rational tangle* is a triple $(B, T; D)$, where (B, T) is a trivial tangle, and D is a disk on ∂B containing two ends of T . We assign a rational number or ∞ to the tangle as follows. Let F be a torus which double branch covers ∂B with branch set ∂T . Let m be a component of the lifting of ∂D , and let l be a curve on F intersecting m once. Orient m, l so that the intersection number of m with l is $+1$ with respect to the orientation of F induced from a fixed orientation of ∂B . (The pair (m, l) is called a coordinate system of F .) Let γ be a curve on ∂B which bounds a disk Δ in B separating

the strings of T . Then the lifting of γ represents some $pm + ql$ in $H_1(F)$. We say that $(B, T; D)$ is a p/q rational tangle, and use $T(p/q)$ to denote it. Because of the ambiguity of the choice of l , the number p/q is defined mod \mathbb{Z} . Thus $T(r) = T(r')$ if and only if $r = r' \pmod{\mathbb{Z}}$. One can check that if a tangle is a (p, q) rational tangle in the usual sense (see e.g. [HT]), and if we choose the left hand side disk as the disk D , then it is a $T(p/q)$ according to our definition.

Given two tangles (B_1, T_1) and (B_2, T_2) , we can choose a disk D_i on ∂B_i , then glue the two disks D_i together to form a new tangle (B, T) . We say that (B, T) is a *sum* of $(B_1, T_1; D_1)$ and $(B_2, T_2; D_2)$, and write $(B, T) = (B_1, T_1) \cup_D (B_2, T_2)$, where $D = D_1 = D_2$. This process depends on the choice of D_i and the gluing map. When D_i is not important, we will simply say that (B, T) is the sum of (B_1, T_1) and (B_2, T_2) . If neither of $(B_i, T_i; D_i)$ is $T(0)$ or $T(\infty)$, we say that the sum is a nontrivial sum. A tangle is called an *algebraic tangle* if it is obtained by nontrivially summing rational tangles together in various ways. Thus a nontrivial sum of algebraic tangles is still an algebraic tangle.

A *Montesinos tangle* $T(r_1, \dots, r_n)$ is obtained by gluing rational tangles $T(r_i) = (B_i, T_i; D_i)$ together so that D_i is glued to the disk $\partial B_{i+1} - \text{Int}D_{i+1}$, where r_i are non integral rational numbers. When further gluing D_n to $\partial B_1 - \text{Int}D_1$, we get a *Montesinos link* $L(r_1, \dots, r_n)$, also known as star link [Oe]. The number n is called the length of L . When $n = 1$, L is a 2-bridge link.

Given two tangles (B_1, T_1) and (B_2, T_2) , we may glue the boundaries of the B_i together so that $T_1 \cup T_2$ becomes a link L in $S^3 = B_1 \cup B_2$. A link L is an *arborescent link* if either it is a Montesinos link, or (S^3, L) is the union of two algebraic tangles (B_1, T_1) and (B_2, T_2) , each of which has length at least 2. Note that if (B_1, T_1) has length ≥ 3 and (B_2, T_2) has length = 1 then $(B_1, T_1) = (B'_1, T'_1) \cup (B''_1, T''_1)$, where length of (B'_1, T'_1) is ≥ 2 , so (S^3, L) can be rewritten as a union of (B'_1, T'_1) and (B'_2, T'_2) , where (B'_2, T'_2) is a sum of (B''_1, T''_1) and (B_2, T_2) . The above restriction about the length of (B_i, T_i) is to make sure that $(B'_2, T'_2) = (B''_1, T''_1) \cup (B_2, T_2)$ is a nontrivial sum.

Let $L = l_1 \cup \dots \cup l_n$ be a link in a 3-manifold M . A *slope* γ is a set of curves $\gamma_1 \cup \dots \cup \gamma_n$, where γ_i is an essential curve on $\partial N(l_i)$. We use $(M, L; \gamma)$ to denote the manifold obtained from M by surgery on L along γ , that is, $(M, L; \gamma) = (M - \text{Int}N(L)) \cup (V_1 \cup \dots \cup V_n)$, where γ_i bounds a disk in the solid torus V_i . When $M = S^3$, the surgered manifold $(M, L; \gamma)$ is simply denoted by $L(\gamma)$.

Lemma 1.1. *Let $T(p/q) = (B, t_1 \cup t_2; D)$ be a rational tangle. If ∂D bounds a disk Δ in $E(T)$, then $q = 0$.*

Proof. The disk Δ separates the two strings t_1 and t_2 . Since both t_i are trivial strings in B , t_1 is rel ∂t_1 isotopic to a string on D or $\partial B - D$ without crossing t_2 . \square

Lemma 1.2. *Let $T(p/q) = (B, T; D)$ be a rational tangle. If $\partial E(T) - \partial D$ is compressible in $E(T)$, then $q \leq 1$.*

Proof. Let W be the manifold obtained from $E(T)$ by attaching a 2-handle to $E(T)$ along ∂D . Note that W is the exterior of a 2-bridge link $L(p/q)$. We use the fact that if $q \geq 2$ then L is a nontrivial link. In particular, ∂W is incompressible.

Let Δ be a compressing disk of $\partial E(T) - \partial D$ in $E(T)$. Then Δ is a compressing disk of ∂W unless $\partial \Delta$ is a trivial curve on ∂W , which happens only if (1) $\partial \Delta$

is parallel to ∂D , or (2) $\partial \Delta$ bounds a torus on $\partial E(T)$ containing ∂D as a non-separating curve. In the first case, ∂D bounds a disk in $E(T)$, so by Lemma 1.1 we have $q = 0$. In the second case, Δ cuts $E(T)$ into two solid tori, because $E(T)$ is a handlebody of genus 2. A meridian disk of the solid torus which does not contain ∂D would then be a compressing disk of ∂W . \square

2. SURGERY ON KNOTS IN TANGLE SPACES

Let $(B, T) = (B, t_1 \cup t_2 \cup K)$ be a tangle, where t_i are arcs, and K is a closed circle in B . After γ surgery on K , we get a manifold $B' = (B, K; \gamma)$. We want to know whether the manifold $M = B' - \text{Int}N(t_1 \cup t_2)$ is irreducible and ∂ -irreducible. Recall that a manifold M is ∂ -irreducible if its boundary is incompressible. The main result of this section is Theorem 2.7, which solves this problem for Montesinos tangles of length 2. The result will be used in the next section to prove Theorem 3.4.

We use m to denote a meridian of the knot K .

Lemma 2.1. *Let F be a compressible surface on the boundary of a 3-manifold M , let K be a knot in M . If F is compressible in $(M, K; \gamma)$ for some $\gamma \neq m$, then it is compressible in $(M, K; \gamma')$ for some γ' with $\Delta(\gamma', m) = 1$.*

Proof. We may assume that F is incompressible in $M - K$, and $M - \text{Int}N(K)$ is not a $T^2 \times I$, otherwise F is compressible in $(M, K; \gamma)$ for all γ . If there is no essential annulus A in $M - \text{Int}N(K)$ with one boundary on each of F and $\partial N(K)$, then by [Wu3, Theorem 1], F is incompressible in $(M, K; \gamma)$ unless $\Delta(\gamma, m) \leq 1$, so we may choose $\gamma' = \gamma$.

Now assume that there is an essential annulus A in $M - \text{Int}N(K)$ with one boundary on each of F and $\partial N(K)$, and let γ_0 be the slope $A \cap \partial N(K)$. If $\gamma_0 = m$, then again F is compressible in $(M, K; \gamma)$ only if $\Delta(\gamma, m) \leq 1$ [CGLS, Theorem 2.4.3], so we can choose $\gamma' = \gamma$. If $\gamma_0 \neq m$, by [CGLS, Theorem 2.4.3] F is compressible in $(M, K; \gamma)$ if and only if $\Delta(\gamma_0, \gamma) \leq 1$. In particular, $\Delta(\gamma_0, m) = 1$. Thus if we choose $\gamma' = \gamma_0 + m$ (homologically), then $\Delta(m, \gamma') = 1$. Since $\Delta(\gamma_0, \gamma') = \Delta(\gamma_0, \gamma_0 + m) = 1$, F is compressible in $(M, K; \gamma')$. \square

The following result is due to Starr [St].

Lemma 2.2. *Let C be a simple closed curve on the boundary of a handlebody M . Then $\partial M - C$ is incompressible in M if and only if there exists a set of disks D_1, \dots, D_k in M , such that (1) $\partial D_1 \cup \dots \cup \partial D_k$ cuts ∂M into P_1, \dots, P_r , each of which is a pair of pants, (2) $C \cap P_i$ are essential arcs, with at least one arc connecting any two components of ∂P_i . \square*

Lemma 2.3. *Let $T(p/q) = (B, T; D) = (B, t_1 \cup t_2; D)$. Let $T(1/0) = (B, T'; D) = (B, t'_1 \cup t'_2; D)$. Let D' be another disk on ∂B such that $(B, T; D')$ is a $T(1/0)$. Then $(B, T'; D') = T(-s/q)$ with $ps \equiv 1 \pmod q$. In particular, if $p \not\equiv \pm 1 \pmod q$, then $s \not\equiv \pm 1 \pmod q$.*

Proof. Let $F \rightarrow \partial B$ be a double branched cover with branch set ∂T . Let (m, l) be a coordinate system of F such that m covers ∂D . Similarly, let (m', l') be a coordinate system with m' covering $\partial D'$. Since $(B, T; D')$ is a $1/0$ tangle, $\partial D'$ bounds a disk Δ' in B which separates the strings of T . So by our definition m'

represents $pm + ql$ in $H_1(F)$. Thus

$$\begin{pmatrix} m' \\ l' \end{pmatrix} = \begin{pmatrix} p & q \\ r & s \end{pmatrix} \begin{pmatrix} m \\ l \end{pmatrix}$$

for some r, s such that $ps - qr = 1$. So

$$\begin{pmatrix} m \\ l \end{pmatrix} = \begin{pmatrix} s & -q \\ -r & p \end{pmatrix} \begin{pmatrix} m' \\ l' \end{pmatrix}.$$

In particular, $m = sm' - ql'$. Since m covers ∂D , which bounds a disk in B separating the strings of T' , this implies that $(B, T; D')$ is a $T(-s/q)$. From $ps - qr = 1$ we see that $ps \equiv 1 \pmod{q}$. \square

Lemma 2.4. *Let $T(p/2q) = (B, T; D) = (B, t_1 \cup t_2; D)$. Let P be the punctured torus on $\partial E(T)$ bounded by ∂D , containing $Q = D \cap E(T)$. Let C be a circle in P intersecting both Q and $A = P - \text{Int}Q$ in $k \geq 1$ essential arcs. If $p \not\equiv \pm 1 \pmod{2q}$, then $\partial E(T) - C$ is incompressible in $E(T)$.*

Proof. Without loss of generality we may assume that t_1 is the component of T with ends on D . Let γ be an arc in D with $\partial\gamma = \partial t_1$. Choose another disk D' on ∂B such that $(B, T; D') = T(1/0)$. Then by Lemma 2.3 γ is an arc on ∂B having slope $-r/2q$, and $rp \equiv 1 \pmod{2q}$. Since $p \not\equiv \pm 1 \pmod{2q}$, we may assume that $1 < -r < 2q - 1$.

Let Δ be a properly embedded disk in B containing T . Then $\Delta \cap E(T)$ consists of three disks D_1, D_2, D_3 , cutting $E(T)$ into two 3-balls W_1 and W_2 , see Figure 2.1(a). Now $\partial\Delta$ intersects $\partial E(T)$ in four arcs e_1, \dots, e_4 , as shown in Figure 2.1(b). Let P_i be the pair of pants $\partial E(T) \cap W_i$. Note that the two vertical arcs e_1 and e_2 on $\partial E(T)$ belong to different component $\partial D_1, \partial D_3$ of ∂P_i , and the two horizontal arcs e_3 and e_4 belong to the other component ∂D_2 of ∂P_i .

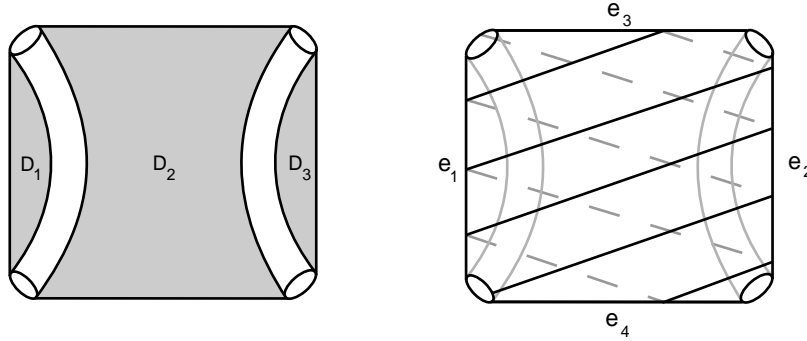

Figure 2.1

By an isotopy of C we may assume that $C \cap P_i$ consists of essential arcs. Each component α_j of $C \cap Q$ is a copy of $\gamma \cap Q$, so it is an arc of slope $-r/2q$ on $\partial E(T)$, as shown in Figure 2.1(b), where $-r/2q = 3/8$. Since $1 < -r < 2q - 1$, $\alpha_j \cap P_i$ has some arcs connecting e_1 to e_2 and some arcs connecting $e_3 \cup e_4$ to each of e_1 and e_2 . Therefore, for each i , and each pair of boundaries ∂_j, ∂_k of ∂P_i , there are arcs of $C \cap P_i$ connecting ∂_j to ∂_k . It follows from Lemma 2.2 that $\partial E(T) - C$ is incompressible. \square

Lemma 2.5. *Let P, Q, A , and $T(p/2q)$ be as in Lemma 2.4.*

(1) *If $q \neq 0$, then P and $\partial E(T) - P$ are incompressible.*

(2) *If $p \neq \pm 1 \pmod{2q}$, there is no compressing disk of $\partial E(T)$ intersecting P at just one arc.*

Proof. (1) Assuming the contrary, let Δ be a compressing disk of P in $E(T)$. If $\partial\Delta$ is a separating curve in P , then $\partial\Delta = \partial P$ bounds a disk in $B - t_1 \cup t_2$, which would imply that T is a $1/0$ tangle. If $\partial\Delta$ is non-separating, then ∂P , being coplanar to $\partial\Delta$, also bounds a disk in $E(T)$, which again would imply that $q = 0$. Similarly one can show that $\partial E(T) - P$ is incompressible.

(2) Let Δ be a compressing disk of $\partial E(T)$ intersecting P in an essential arc γ . If γ were disjoint from A then by [Wu1, Lemma 2.1] T would be a $1/2$ tangle. So assume $k = |\gamma \cap A| > 0$, and k is minimal up to isotopy of γ . Let γ' be an arc on ∂P with $\partial\gamma' = \partial\gamma$. Pushing $\gamma \cup \gamma'$ off γ and ∂P , we get a circle C in P which intersects both Q and A in k essential arcs. Since Δ is a compressing disk of $\partial E(T) - C$, this contradicts Lemma 2.4. \square

Lemma 2.6. *Let $T = T(1/2, p/2q) = (B, t_1 \cup t_2 \cup K)$ be a tangle such that $p \not\equiv \pm 1 \pmod{q}$. Put $M = B - \text{Int}N(t_1 \cup t_2)$, and $M(\gamma) = (M, K; \gamma)$. Let m_1 be a meridional circle of t_1 on $\partial N(t_1) \subset \partial M$. Then*

(1) *$M(\gamma)$ is a handlebody for all γ ;*

(2) *$\partial M(\gamma) - m_1$ is incompressible in $M(\gamma)$ for all $\gamma \neq m$, where m is the meridian slope of K .*

Proof. (1) $T = T(1/2, p/2q)$ is a sum of $T_1 = T(1/2) = (B_1, t_1 \cup t'_1, D_1)$ and $T_2 = T(p/2q) = (B_2, t'_2 \cup t_2, D_2)$, and $K = t'_1 \cup t'_2$. Notice that $B_1 - \text{Int}N(t_1)$ is a solid torus, and t'_1 is the arc shown in Figure 2.2(a). Thus gluing $B_1 - \text{Int}N(t_1)$ to $(B_2, t'_2 \cup t_2)$ is the same as adding a 1-handle $D^2 \times I$ to B_2 so that $D^2 \times \partial I$ is glued to a neighborhood of $\partial t'_2$ in ∂B_2 , and the ends of $t'_1 = 0 \times \partial I$ are glued to $\partial t'_2$. See Figure 2(b). Since $(B_2, t'_2 \cup t_2)$ is homeomorphic to the trivial tangle, $K = t'_1 \cup t'_2$ is a central curve of the solid torus $V = (B_1 - \text{Int}N(t_1)) \cup B_2 = B - \text{Int}N(t_1)$, and t_2 is properly isotopic to a trivial arc in $V - K$, as shown in Figure 2(c). It is now clear that $M(\gamma)$, the manifold obtained from $V - \text{Int}N(t_2)$ by surgery on K , is a handlebody of genus 2. This proves (1).

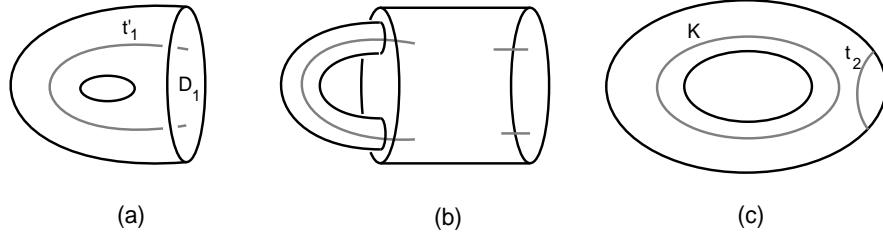

Figure 2.2

(2) Clearly, $F = \partial M - m_1$ is compressible in M , so by Lemma 2.1, we need only show that F is incompressible in $M(\gamma)$ for all γ such that $\Delta(m, \gamma) = 1$.

As above, $B - \text{Int}N(t_1)$ can be obtained by gluing a 1-handle $H = D^2 \times I$ to B_2 . Let W be the solid torus $H \cup N(t'_2)$, let $X = B_2 - \text{Int}N(t'_2 \cup t_2) = E(T_2)$. Then $B - \text{Int}N(t_1 \cup t_2) = W \cup_A X$, where $A = W \cap X$ is an annulus identified to a meridional annulus on W and to $\partial N(t'_2)$ on X .

Let α be an arc of slope $1/0$ on ∂B_2 , connecting the ends of t'_2 . Let $\alpha' = \alpha \cap X$. Then m_1 is the union of α' and an arc β on the boundary of the 1-handle H . Since $\Delta(m, \gamma) = 1$, $W' = (W, K; \gamma)$ is a solid torus such that A is a longitudinal annulus. Therefore $M(\gamma) = W' \cup_A X$ is homeomorphic to X . The homeomorphism sends β to an arc β' on $\partial N(t'_2)$. Therefore $(M(\gamma), m_1) \cong (X, \alpha' \cup \beta')$. Now we can apply Lemma 2.4, and conclude that $\partial M - m_1 = \partial X - \alpha \cup \beta$ is incompressible in $M(\gamma) = X$. \square

Theorem 2.7. *Let $T = T(r/2s, p/2q) = (B, t_1 \cup t_2 \cup K)$ be a tangle such that $s > 1$, and $p \not\equiv \pm 1 \pmod{2q}$. Let K be the closed component of T , and let $M = B - \text{Int}N(t_1 \cup t_2)$. Then ∂M is incompressible in $(M, K; \gamma)$ for all $\gamma \neq m$, where m is the meridional slope of K .*

Proof. By Lemma 2.1, we need only prove the theorem for γ with $\Delta(m, \gamma) = 1$.

Let $T_1 = T(r/2s) = (B_1, t_1 \cup t'_1, D_1)$, and $T_2 = T(p/2q) = (B, t'_2 \cup t_2, D_2)$. Let $D = D_1 = D_2$ be the disk in B cutting (B, T) into (B_1, T_1) and (B_2, T_2) . Let $P_i = Q_i \cup A_i$ be the punctured torus on $\partial E(T_i)$ bounded by ∂D_i , where $Q_i = D_i \cap E(T_i)$, and $A_i = N(t'_i) \cap \partial E(T_i)$.

P_2 cuts M into two pieces X and Y , where $X = (B_1 \cup \text{Int}N(t_1)) \cup N(t'_2)$, and $Y = B_2 - \text{Int}N(t'_2 \cup t_2) = E(T_2)$. By the argument in the proof of Lemma 2.6, we see that when $\Delta(m, \gamma) = 1$, $(X, K; \gamma) \cong E(T_1)$, with P_2 on ∂X identified to P_1 on $\partial E(T_1)$. Hence, $(M, K; \gamma) = (X, K; \gamma) \cup_{P_2} Y \cong E(T_1) \cup_P E(T_2)$, where P is identified to P_i on $\partial E(T_i)$. By Lemma 2.5, P is incompressible in $(M, K; \gamma)$, and if $r \not\equiv \pm 1 \pmod{2s}$, then P is also ∂ -incompressible in $(M, K; \gamma)$, so P is an essential surface in $(M, K; \gamma)$. By a standard innermost circle – outermost arc argument, one can show that ∂M is incompressible in $(M, K; \gamma)$ in this case.

Now we may assume without loss of generality that $r = 1$. Let V be the solid torus $B_1 - \text{Int}N(t_1)$. Since T_1 is a $1/2s$ tangle, t'_1 is rel $\partial t'_1$ isotopic to an arc α on ∂V such that $\alpha \cap (\partial V - D_1)$ is a single arc. Let X be a regular neighborhood of $\alpha \cup D_1$ in V containing t'_1 , and let $Y = V - \text{Int}X$. Thus $V = Y \cup_A X$, and $A = Y \cap X$ is an annulus running $s > 1$ times along the longitude of the solid torus Y .

Now consider $M' = V \cup_D (B_2 - \text{Int}N(t_2)) \subset M$. Notice that if we glue a 2-handle $D^2 \times I$ to V so that $\partial D^2 \times I$ is glued to A , then $(V \cup D^2 \times I, t''_1 \cup t'_1, D_1)$ is a $1/2$ tangle, where $t''_1 = 0 \times I \subset D^2 \times I$. Thus if we put $(B', T') = T(1/2, p/2q) = (B', u_1 \cup u_2 \cup K')$, then M' is homeomorphic to $B' - \text{Int}N(u_1 \cup u_2)$, with K identified to K' , and A to $\partial N(u_1)$. Therefore by Lemma 2.6, $\partial M' - A$ is incompressible in $(M', K; \gamma)$ for all $\gamma \neq m$. As A is an annulus, this implies that A is incompressible. Also, if Δ is a compressing disk of $\partial M'$ in $(M', K; \gamma)$ intersecting A in an essential arc, then the boundary of a regular neighborhood of $\partial \Delta \cup A$ on $\partial M'$ would bound a disk in $(M, K; \gamma)$, contradicting the incompressibility of $\partial M' - A$. We conclude that there is no compressing disk Δ of $\partial M'$ in (M', K, γ) such that $|\partial \Delta \cap A| \leq 1$. Since A runs $s > 1$ times along the longitude of the solid torus Y , any compressing disk of ∂Y also intersects A at least twice.

Notice that $(M, K; \gamma) \cong Y \cup_A (M', K; \gamma)$. The above results show that A is an essential surface in $(M, K; \gamma)$, and there is no compressing disk of ∂M in $(M, K; \gamma)$ disjoint from A . It is now a standard innermost circle – outermost arc argument to show that ∂M is incompressible in $(M, K; \gamma)$. \square

Remark 2.8. The two conditions of Theorem 2.7 are necessary. If $s = 1$ or $p = 1$, by Lemma 2.6 we see that $(M, K; \gamma)$ is a handlebody for all γ . If $r \equiv \pm 1 \pmod{2s}$

and $p \equiv \pm 1 \pmod{2q}$, then K is isotopic to a curve on ∂M , so ∂M is compressible in $(M, K; \gamma)$ for infinitely many γ . Theorem 2.7 covers the remaining cases.

3. DEHN SURGERY ON SUFFICIENTLY COMPLICATED ARBORESCENT LINKS

In this section we will prove Theorem 3.4, which says that if L is an arborescent link composed of algebraic tangles satisfying certain conditions, then all surgeries on L are Haken. The main difficulty in dealing with surgery on links is that surgery on different components of L will interact each other. The idea here in proving Theorem 3.4 is to find a branched surface in the link complement, cutting the link complement into simpler pieces, so that we can deal with each piece separately.

Given a branched surface \mathcal{F} in a 3-manifold M , we use $E(\mathcal{F})$ to denote the exterior of \mathcal{F} , i.e. $E(\mathcal{F}) = M - \text{Int}N(\mathcal{F})$. We refer the reader to [GO] for definitions of essential laminations, essential branched surfaces, and related concepts such as horizontal and vertical surfaces. Recall that the vertical surfaces are annuli on $\partial E(\mathcal{F})$. We call them *cusps*.

Lemma 3.1. *Let L be an arborescent link of length ≥ 4 . Then there is a branched surface \mathcal{F} in $E(L) = S^3 - \text{Int}N(L)$ such that each component M of $E(\mathcal{F}) = S^3 - \text{Int}N(\mathcal{F})$ is of one of the following types.*

(a) $M = B - \text{Int}N(t_1 \cup t_2)$, where $(B, t_1 \cup t_2) = T(p_1/q_1, p_2/q_2)$, and at least one of the q_i is odd; ∂M has no cusps; $M \cap L = \emptyset$.

(b) $M = B - \text{Int}N(t_1 \cup t_2)$, where $(B, t_1 \cup t_2 \cup K) = T(p_1/q_1, p_2/q_2)$, both q_i are even; ∂M has no cusps; $M \cap L = K$.

(c) $M = B - \text{Int}N(t_1 \cup t_2)$, where $(B, t_1 \cup t_2; D) = T(p/q)$ is a rational tangle with $q \geq 2$; ∂M has a cusp at ∂D ; $M \cap L = \emptyset$.

(d) M is a solid torus, ∂M has 3 cusps, each of which is a longitude of M ; $M \cap L = \emptyset$.

(e) $M = N(K_i)$, K_i is a component of L ; M has at least two meridional cusps; $M \cap L = K_i$.

Proof. By assumption (S^3, L) is the union of two tangles (B_1, T_1) and (B_2, T_2) , each of which is an algebraic tangle of length ≥ 2 . Let \mathcal{F} be a branched surface in B , where (B, T) is a tangle. A component M of $E(\mathcal{F})$ is called an *inner component* if it is disjoint from ∂B , otherwise it is an *outer component*. All components of $S^3 - \text{Int}N(\mathcal{F})$ are inner components.

For each algebraic tangle (B, T) of length ≥ 2 and for each arborescent link (S^3, L) of length ≥ 4 , we construct inductively a branched surface \mathcal{F} in B or S^3 , satisfying

(*) *Each inner component of $E(\mathcal{F})$ is of one of the types listed in the lemma, and each outer component is a neighborhood of an arc of T , with possibly some meridional cusps.*

CASE 1. (B, T) has length = 2.

Then $(B, T) = T(p_1/q_1, p_2/q_2)$ with $q_i \geq 2$. If at least one of the q_i is odd, then $T = t_1 \cup t_2$, and we choose $\mathcal{F} = \partial E(T)$.

If both q_i are even, $T = t_1 \cup t_2 \cup K$, where K is a circle component of T . Let $\mathcal{F} = \partial(B - \text{Int}N(t_1 \cup t_2))$.

In both cases \mathcal{F} is a genus 2 surface containing the punctured sphere $\partial B - \text{Int}N(T)$.

It is clear that in this case an inner component M of $B - \text{Int}N(\mathcal{F})$ is of type (a) or (b) in the lemma. An outer component of $B - \text{Int}N(\mathcal{F})$ is a neighborhood of t_i . Therefore (*) holds.

CASE 2. $(B, T) = (B_1, T_1) \cup_D (B_2, T_2)$, where (B_2, T_2, D) is a rational tangle $T(p/q)$ for some $q \geq 2$.

By Case 1, we may assume that (B_1, T_1) is not a rational tangle. So by induction we have a branched surface \mathcal{F}_1 in B_1 satisfying (*). In particular, $\mathcal{F}_1 \cap \partial B_1 = \partial B_1 - \text{Int}N(T_1)$.

Define $\mathcal{F} = \mathcal{F}_1 \cup \partial E(T_2)$. Since $\mathcal{F}_1 \cap \partial E(T_2)$ is a pair of pants P , there are three new branch loci $\partial_0 \cup \partial_1 \cup \partial_2 = \partial P$. We smooth \mathcal{F} so that the cusp at $\partial_0 = \partial D$ is inside of $E(T_2)$, and the cusps on ∂_1 and ∂_2 are outside of both $E(T_1)$ and $E(T_2)$, so they are in $N(T)$, see Figure 3.1.

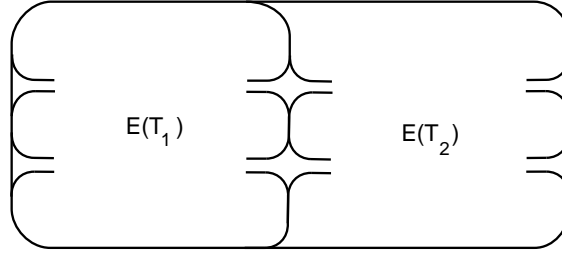

Figure 3.1

Let M be an inner component of $B - \text{Int}N(\mathcal{F})$. Then one of the following holds.

- (i) M is an inner component of $B_1 - \text{Int}N(\mathcal{F}_1)$;
- (ii) $M = E(T_2)$, with a cusp at ∂D ;
- (iii) M is the union of $N(t_2)$ and an outer component of $B_1 - \text{Int}N(\mathcal{F}_1)$, where t_2 is a string of T_2 .

In case (i) M is of one of the types in the lemma by induction. In case (ii) M is of type (c). In case (iii) M is of type (e), where the two meridional cusps are the cusps at ∂_1 and ∂_2 in the above construction. Note that (iii) happens only if both T_i has a string with both ends on D . It is also easy to see that an outer component of $B - \text{Int}N(\mathcal{F})$ is a neighborhood of a string of T . Therefore (*) holds for \mathcal{F} .

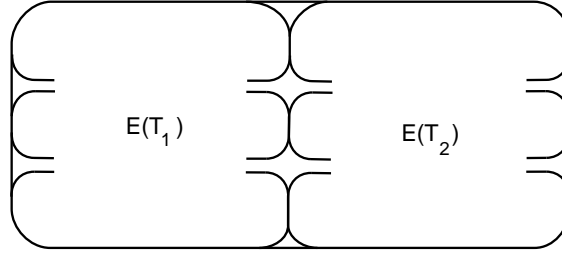

Figure 3.2

CASE 3. $(B, T) = (B_1, T_1) \cup_D (B_2, T_2)$, and neither of (B_i, T_i) is a rational tangle.

By induction we may assume that we have constructed branched surfaces \mathcal{F}_i in B_i satisfying (*), so $\mathcal{F} \cap \partial B_i = \partial B_i - \text{Int}N(T_i)$. Construct \mathcal{F} as in Figure 3.2. More explicitly, let $\partial_0 = \partial D$ be the outer boundary of $P = D - \text{Int}N(T)$ in $B_1 \cup B_2$. We

can think of B as the union of $B_1 \cup B_2$ and a solid torus N which has a longitudinal annulus A' glued to a neighborhood of ∂_0 on $\partial(B_1 \cup B_2)$. Then $\mathcal{F} = \mathcal{F}_1 \cup \mathcal{F}_2 \cup A$, where A is the annulus $\partial N - \text{Int}A'$. It has five new branch loci. We smooth it so that at the two inner boundary components of P it is smoothed in the same way as in Case 2, and the three cusps on ∂N are on the side of N .

An inner component M of $B - \text{Int}N(\mathcal{F})$ is of one of the following types.

- (i) M is an inner component of $B_i - \text{Int}N(\mathcal{F}_i)$;
- (ii) M is the solid torus in N above, with three longitudinal cusps, and $M \cap T = \emptyset$;
- (iii) $M = N(K)$ with at least two meridional cusps, where K is the union of two strings, one in each T_i .

By induction we see that M is of one of the types in the lemma. Note that in case (ii) M is of type (d). One can check that an outer component is a neighborhood of a string of T , with possibly some meridional cusps.

CASE 4. $(S^3, L) = (B_1, T_1) \cup (B_2, T_2)$, where (B_i, T_i) are algebraic tangles of length ≥ 2 .

Let \mathcal{F}_i be the branched surface in B_i constructed above. Define $\mathcal{F} = \mathcal{F}_1 \cup \mathcal{F}_2$, smoothed so that the four new cusps lie between \mathcal{F}_1 and \mathcal{F}_2 . In other words, the new cusps are in the solid tori whose intersection with B_i is a regular neighborhood of the arcs in T_i . A component M of $S^3 - \text{Int}N(\mathcal{F})$ is either an inner component of $B_i - \text{Int}N(\mathcal{F}_i)$, or is the union of two or four outer components of $B_i - \text{Int}N(\mathcal{F}_i)$. In the later case it is an $N(K_i)$ for some component K_i of L , with at least two meridional cusps on its boundary, so it is of type (e). Since each inner component of $B_i - \text{Int}N(\mathcal{F}_i)$ is of one of the types listed in the lemma, the result follows. \square

Lemma 3.2. *Let \mathcal{F} be a branched surface such that its branch loci are mutually disjoint simple closed curves, cutting \mathcal{F} into an orientable surface S . Then \mathcal{F} fully carries a lamination.*

Proof. $N(\mathcal{F})$ is obtained from $S \times I$ by gluing $\partial S \times I$ together in certain way. Laminating $S \times I$ by $S \times C$ for a Cantor set C in I , and choosing the gluing map to preserve the lamination, we get the required lamination. See for example the construction of [GO, Example 5.1]. \square

Corollary 3.3. *Let \mathcal{F}_1 be a branched surface in a 3-manifold M . Let F be a two sided surface in \mathcal{F}_1 having a collar $N = F \times I$ in M such that $\mathcal{F}_1 \cap (F \times I) = F \times 0 = F$. Let \mathcal{F} be a branched surface obtained by gluing a surface G to \mathcal{F}_1 so that $G \cap N = \partial G \times I$. If \mathcal{F}_1 fully carries a lamination, so does \mathcal{F} .*

Proof. We can split $N(\mathcal{F})$ along F into $N(\mathcal{F}_1)$ and $N(\mathcal{F}_2)$, where \mathcal{F}_2 is a branched surface homeomorphic to $F \cup G$. By assumption and Lemma 3.2, each $N(\mathcal{F}_i)$ fully carries a lamination λ_i . Thus $\lambda = \lambda_1 \cup \lambda_2$ is a lamination fully carried by \mathcal{F} . \square

Theorem 3.4. *Let $L = k_1 \cup \dots \cup k_n$ be an arborescent link of length ≥ 4 , so that (1) L is composed of rational tangles $T(p_i/q_i)$ with $q_i > 2$, and (2) no length 2 tangle of L is of the form $T(1/2q_1, 1/2q_2)$ for some integers q_1, q_2 . Then all complete surgeries on L produce Haken manifolds.*

Proof. Let W be a manifold obtained from S^3 by a complete surgery on L . Let \mathcal{F} be the branched surface constructed in Lemma 3.1. We want to show that \mathcal{F} is an essential branched surface in W . By [GO], W will then be irreducible. Note that $\partial_h \mathcal{F}$ has some closed surface components. Since each leaf of a lamination carried

by an essential surface is π_1 -injective, a closed surface component of $\partial_h \mathcal{F}$ will be an incompressible surface in W , so W will be a Haken manifold.

To prove that \mathcal{F} is essential in W , according to [GO] we need to prove the following.

- (i) \mathcal{F} has no disk of contact;
- (ii) $\partial_h \mathcal{F}$ is incompressible, has no sphere components, and has no monogons;
- (iii) Each component M of $W - \text{Int}N(\mathcal{F})$ is irreducible;
- (iv) \mathcal{F} contains no Reeb branched surface;
- (v) \mathcal{F} fully carries a lamination.

By the construction of \mathcal{F} one can see that each branch locus is a homotopically nontrivial curve in \mathcal{F} , so (i) and (iv) hold. It is also easy to see that $\partial_h \mathcal{F}$ has no sphere components.

Let M be a component of $S^3 - \text{Int}N(\mathcal{F})$. Then it is of one of the five types in Lemma 3.1. We want to show that after surgery it is irreducible, and $\partial_h \mathcal{F} \cap \partial M$ is incompressible and has no monogons.

If M is of type (a), then $M = E(T)$ for some $T = T(p_1/q_1, p_2/q_2)$, and at least one of the q_i is odd. Since we have assumed $q_i \neq 2$, by [Wu1, Lemma 3.3] $\partial M = \partial_h \mathcal{F} \cap M$ is incompressible. It has no monogons because there is no cusps on ∂M . As a tangle space, M is irreducible. Since $M \cap L = \emptyset$, these properties persist after surgeries.

If M is of type (b), then $M = B - \text{Int}N(t_1 \cup t_2)$ for some $(B, t_1 \cup t_2 \cup K) = T(p_1/2q_1, p_2/2q_2)$, where K is the circle component of the tangle, and is a component of L . Our assumption says that $p_i \not\equiv \pm 1 \pmod{2q_i}$. By Theorem 2.7, the manifold $(M, K; \gamma)$ obtained from M by some nontrivial surgery on K is irreducible and ∂ -irreducible.

If M is of type (c), $M = E(T)$ for some rational tangle $T(p/q) = (B, t_1 \cup t_2, D)$, and $\partial M \cap \partial_h \mathcal{F} = \partial M - \partial D$, which is incompressible by Lemma 1.2. Since ∂M has genus > 1 , this implies that there is no monogon. As a tangle space, M is irreducible.

In case (d), M is a solid torus with 3 longitudinal cusps, and $M \cap L = \emptyset$, so the result is obvious.

In case (e), $M = N(k_i)$ for some component k_i of L , and ∂M has at least two meridional cusps. After surgery on k_i , M remains a solid torus, but the cusps becomes non-meridional. Since there are at least two cusps, $\partial_h \mathcal{F} \cap \partial M$ is incompressible and has no monogons after surgery.

In summary, (ii) and (iii) hold for all components of $W - \text{Int}N(\mathcal{F})$.

It remains to show that \mathcal{F} fully carries a lamination λ . We follow the steps in the construction of \mathcal{F} in Lemma 3.1.

In Case 1, \mathcal{F} is a surface. We can simply take λ to be $\mathcal{F} \times \partial I$ in $N(\mathcal{F}) = \mathcal{F} \times I$.

In Case 2, $\mathcal{F} = \mathcal{F}_1 \cup \partial E(T_2) = \mathcal{F}_1 \cup G$, where G is the closed up surface of $\partial E(T_2) - \mathcal{F}_1$. Let F be the surface $\partial E(T_1)$ in \mathcal{F}_1 . Then \mathcal{F}_1 , F and G satisfy the conditions of Corollary 3.3, so by that corollary and induction, \mathcal{F} fully carries a lamination.

In Case 3, $\mathcal{F} = \mathcal{F}_1 \cup \mathcal{F}_2 \cup A$. Let S_i be the surface $\partial E(T_i)$ on \mathcal{F}_i . Then $N(\mathcal{F})$ can be split into three pieces homeomorphic to $N(\mathcal{F}_1)$, $N(\mathcal{F}_2)$, and $N(S_1 \cup S_2 \cup A)$, respectively. By induction $N(\mathcal{F}_i)$ fully carries a lamination λ_i . By Lemma 3.2 $N(S_1 \cup S_2 \cup A)$ also fully carries a lamination λ_3 . Thus $\lambda = \lambda_1 \cup \lambda_2 \cup \lambda_3$ is a lamination fully carried by $N(\mathcal{F})$.

In Case 4, $N(\mathcal{F})$ can be split into $N(\mathcal{F}_1)$ and $N(\mathcal{F}_2)$. If λ_i is a lamination in $N(\mathcal{F}_i)$ fully carried by \mathcal{F}_i , then $\lambda = \lambda_1 \cup \lambda_2$ is one fully carried by \mathcal{F} . \square

4. SURGERY ON TWO COMPONENT ARBORESCENT LINKS

Lemma 4.1. *Let $(B, t_1 \cup t_2 \cup K) = (B_1, t_1 \cup t'_1) \cup_D (B_2, t_2 \cup t'_2)$ be an algebraic tangle with $K = t'_1 \cup t'_2$, such that neither $(B_i, t_i \cup t'_i; D)$ is the $(1/2)$ -tangle $T(1/2)$. Put $M = B - \text{Int}N(t_1 \cup t_2)$, and $M(\gamma) = (M, K; \gamma)$. Let m_i be a meridional circle of t_i on $\partial N(t_i) \subset \partial M$. Then $M(\gamma)$ is irreducible, and $\partial M - m_1 \cup m_2$ is incompressible in $M(\gamma)$.*

Proof. Let $X_i = B_i - \text{Int}N(t_i \cup t'_i)$ be the exterior of the tangle $(B_i, t_i \cup t'_i)$. Let W be a regular neighborhood of $D \cup K$. The frontier of W consists of two once-punctured tori, denoted by Q_1 and Q_2 . They cut B into three pieces. One of them is W . The other two are homeomorphic to X_1 and X_2 , and will still be denoted by X_1 and X_2 respectively. Up to relabeling we may assume that $Q_i = X_i \cap W$. Since each $(B_i, t_i \cup t'_i; D)$ a nontrivial algebraic tangle, Q_i is incompressible in $E(T_i)$.

Let $W(\gamma)$ denote that manifold obtained from W by Dehn surgery on K along the slope γ . We can consider W as the union of $N(K)$ and $P \times I$ along two annuli $A_1 \cup A_2$, where $P = D - \text{Int}N(K)$ is a twice punctured disk. After surgery, the solid torus $V = N(K)$ becomes a new solid torus $V(\gamma)$, on which A_i becomes non-meridional annuli. By a standard innermost circle outermost arc argument one can show that $W(\gamma) = (P \times I) \cup_{A_1 \cup A_2} V(\gamma)$ is irreducible, and Q_i is incompressible in $W(\gamma)$. Since $M(\gamma) = X_1 \cup_{Q_1} W(\gamma) \cup_{Q_2} X_2$, we see that $M(\gamma)$ is irreducible.

Now suppose $F = \partial M - m_1 \cup m_2$ is compressible in $M(\gamma)$, with Δ a compressing disk. Let $F_i = F \cap \partial X_i$, $i = 1, 2$, and let A be the annulus $F \cap W$. Since $(B_i, t_i \cup t'_i)$ are nontrivial algebraic tangles, F_i are incompressible in X_i . Also, A is incompressible, because it is an annulus with boundary the same as the incompressible surface $Q = Q_1 \cup Q_2$. Therefore, $\Delta \cap Q \neq \emptyset$. By minimizing $|\Delta \cap Q|$ we may assume that $\Delta \cap Q$ has no circle components. An outermost arc of $\Delta \cap Q$ on Δ cuts off a disk Δ' with $\partial \Delta' = c_1 \cup c_2$, where c_1 is an arc on Q , and c_2 is an essential arc on one of the F_1, F_2 and A . The arc c_2 can not be on A , because $\partial c_2 = \partial c_1$ must be on the same boundary component of A , but there is no such essential arc on an annulus. If c_2 lies on F_i , then $(B_i, t_i \cup t'_i)$ would be a $T(1/2)$ by Lemma 4.1 of [Wu], contradicting our assumption. Therefore, F is incompressible in $M(\gamma)$. \square

Remark. If $(B, t_1 \cup t_2 \cup K) = T(1/2, 1/2n)$ then $\partial M - m_1 \cup m_2$ is compressible in $M(\gamma)$ for some $\gamma \neq m$.

Theorem 4.2. *Suppose $L = l_1 \cup l_2$ is an arborescent link of two components. If L has length at least 4, and none of the rational tangles used to build L is a $(1/2)$ -tangle, then all complete surgeries on L produce Haken manifolds.*

Proof. Write $(S^3, L) = (B_1, T_1) \cup (B_2, T_2)$, where (B_i, T_i) are algebraic tangles of length ≥ 2 . We separate the proof into two cases.

CASE 1. (*Neither of T_i has a closed circle component.*) Let S be the 2-sphere $B_1 \cap B_2$. Let W be a regular neighborhood of $S \cup L$ in S^3 . Let $Q = \partial W$. It cuts $E(L)$ into three pieces. One of them is W , and the other two are homeomorphic to $E(T_1)$ and $E(T_2)$ respectively, where $E(T_i) = B_i - \text{Int}N(T_i)$ are the tangle spaces. Let $W(\gamma)$ be the manifold obtained from W by γ surgery on L , where $\gamma = \gamma_1 \cup \gamma_2$, γ_i a non-meridional slope on $\partial N(l_i)$. As in the proof of Lemma 4.1, one can show

that $W(\gamma)$ is irreducible and ∂ -irreducible. Since T_1 and T_2 have length at least 2, by Lemma 3.3 of [Wu1] $E(T_i)$ are also irreducible and ∂ -irreducible. Therefore $L(\gamma) = E(T_1) \cup W(\gamma) \cup E(T_2)$ is a Haken manifold.

CASE 2. ($T_2 = t_2 \cup t'_2 \cup K$ has a circle component K .) Suppose $(B_2, T_2) = (B_3, T_3) \cup (B_4, T_4)$. If T_3 still has a circle component, then $(S^3, L) = (B_3, T_3) \cup ((B_4, T_4) \cup (B_1, T_1))$, so we can consider (B_3, T_3) instead. Therefore without loss of generality we may assume that $T_3 = t_3 \cup t'_3$ and $T_4 = t_4 \cup t'_4$ have no circle components. Up to relabeling we may assume that $l_1 = t'_3 \cup t'_4$ is the component of L contained in T_2 .

Let M be the manifold $B_2 - \text{Int}N(t_2 \cup t'_2)$. Let $M(\gamma_1)$ be the manifold obtained from M by γ_1 surgery on K . Since neither of (B_3, T_3) and (B_4, T_4) is a $(1/2)$ -tangle, by Lemma 4.1 $M(\gamma_1)$ is irreducible, and $\partial M - m_2 \cup m'_2$ is incompressible in $M(\gamma_1)$, where m_2 and m'_2 are the meridians of t_2 and t'_2 on ∂M .

Let $Y = B_2 \cup N(L) = M \cup_A V$, where A is a union of two annuli, identified to a neighborhood of $m_2 \cup m'_2$ on ∂M , and to a pair of meridional annuli on boundary of the solid torus $V = \partial N(l_2)$. After γ surgery on L , we get $Y(\gamma) = M(\gamma_1) \cup_A V(\gamma_2)$. Clearly A is incompressible in both $M(\gamma_1)$ and $V(\gamma_2)$, and there is no compressing disk of $\partial V(\gamma_2)$ intersecting A just once. If there is a compressing disk D of $\partial M(\gamma_1)$ intersecting A just once, then the boundary of a regular neighborhood of $A \cup \partial D$ in $\partial M(\gamma_1)$ would bound a disk in $M(\gamma_1)$, contradicting the fact that $\partial M(\gamma_1) - m_2 \cup m'_2$ is incompressible. Thus A is essential in $Y(\gamma)$. By an innermost circle outermost arc argument it follows that $Y(\gamma)$ is irreducible and ∂ -irreducible. As in Case 1, the tangle space $E(T_1)$ is also irreducible and ∂ -irreducible. Therefore $L(\gamma) = E(T_1) \cup Y(\gamma)$ is a Haken manifold. \square

5. SURGERY ON 2-BRIDGE LINKS

An essential lamination in the complement of a link L is *persistent* if it remains essential after all complete surgeries on the link. In this section we study the problem of which 2-bridge link complement contains a persistent lamination. This has been done by Delman [De1, De2] for all 2-bridge knots and most Montesinos knots. It has also been shown in [Wu2] that all non-Montesinos arborescent knot complements contain persistent laminations. In this section we will solve this problem for 2-bridge links.

Two rational numbers p/q and r/s are considered equivalent, denoted by $p/q \equiv r/s$, if $|q| = |s|$, and $p \equiv \pm r \pmod{\mathbb{Z}}$. Recall that $L(p/q)$ and $L(r/s)$ are equivalent if $p/q \equiv r/s$. Denote by $[a_1, \dots, a_k]$ the partial fraction expansion $1/(a_1 - 1/(\dots - a_k) \dots)$. In particular, $[r, s] = 1/(r - 1/s)$.

Theorem 5.1. *A non-torus 2-bridge link $L = L(p/q)$ admits complete, non-laminar surgeries if and only if $p/q \equiv [r, s]$ for some odd integers r and s .*

The proof of the theorem relies heavily on Delman's construction [De2]. Before proving the theorem, let us have a brief review of some basic concepts of [De1, De2].

For each rational number p/q , there is associated a diagram $D(p/q)$, which is the minimal sub-diagram of the Hatcher-Thurston diagram [HT, Figure 4] that contains all minimal paths from $1/0$ to p/q . See [HT, Figure 5] and [De1]. See also below in the proof of Lemma 5.4 for a construction of $D(p/q)$.

To each vertex v_i of $D(p/q)$ is associated a rational number r_i/s_i . It has one of the three possible parities: odd/odd, odd/even, or even/odd, denoted by o/o , o/e ,

and e/o , respectively. Note that the three vertices of any simplex in $D(p/q)$ have mutually different parities.

Let Δ_1, Δ_2 be two simplices in $D(p/q)$ with an edge in common. Assume that the two vertices which are not on the common edge are of parity o/o . Then the arcs indicated in Figure 5.1(a) and (b) are called *channels*. A *path* γ in $D(p/q)$ is a union of arcs, each of which is either an edge of $D(p/q)$ or a channel.

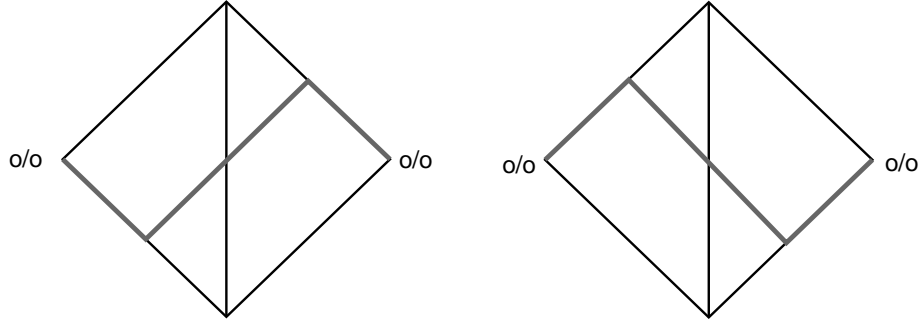

Figure 5.1

Definition 5.2. A path γ in $D(p/q)$ is an *allowable path* if

- (1) γ passes any point of $D(p/q)$ at most once;
- (2) When ignoring the middle points of channels, γ intersects the interior of at most one edge of any given simplex; and
- (3) γ contains at least one channel.

Lemma 5.3. Let $L = L(p/q)$ be a 2-bridge link of two components. If $D(p/q)$ has an allowable path γ which contains at least two channels, then $S^3 - L$ has a persistent lamination.

Proof. Put $(S^3, L) = (B_1, T(1/0)) \cup (B_2, T(p/q))$. Let S be the sphere $B_1 \cap B_2$. A configuration on S is a train track containing a circle around each point of $L \cap S$, and two arcs of slope $1/0$ joining the circles. The tangencies at the branch points determines the type of the configuration. See [De2, Figure 3.1] for the types of configurations. The one in Figure 5.2 was said to be in group I. One can check that with respect to this configuration, a channel by our definition is also a channel in the sense of Delman.

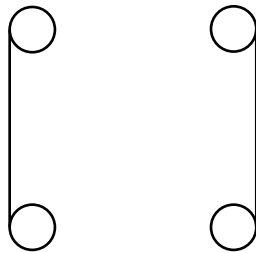

Figure 5.2

Thus given an allowable path γ in $D(p/q)$, we can apply Delman's construction in [De2] to obtain a branched surface \mathcal{F}' in B_2 , such that $\mathcal{F}' \cap \partial B_2$ is the configuration in Figure 5.2. \mathcal{F}' can be extended to a branched surface \mathcal{F} in $S^3 - L$ by adding to

it a trivial branched surface in B_1 , as in [De2, Figure 3.10]. By Proposition 3.1 of [De2], \mathcal{F} is an essential branched surface in $S^3 - L$. The components of $S^3 - \text{Int}N(\mathcal{F})$ containing L form a regular neighborhood of L , denoted by $N(L) = V_1 \cup V_2$, each V_i being a solid torus. Since each channel contributes two cusps on $\partial N(L)$, there are $2k$ cusps on $\partial N(L)$ if γ has k channels.

We claim that each V_i has k cusps. Actually, when examining the construction of the part of \mathcal{F} corresponding to a channel [De2, Section 3], one can see that the two cusps appear around two points of L on some level sphere which have the same orientation. Since each component of L intersects the sphere in two points of different orientation, there must be one cusp for each component of L , so the claim follows.

Thus if $k \geq 2$, then after complete surgeries on L , V_i becomes a solid torus with at least two non-meridional cusps. Since these are the only components of $S^3 - \text{Int}N(\mathcal{F})$ which will change after the surgery, it follows that \mathcal{F} remains an essential branched surface after complete surgery, so any lamination fully carried by \mathcal{F} is persistent. \square

Lemma 5.4. *Suppose q is an even number. Then there is an allowable path in $D(p/q)$ with two channels, unless $p/q \equiv [r, s]$ for some r, s .*

Proof. Replacing p/q by $p'/q = (q - p)/q$ if necessary, we may assume that $0 < p < (q/2)$. Let $[a_1, \dots, a_n]$ be the partial fraction expansion of p/q such that all a_i 's are even. Since q is even, n is odd. We may assume $n \geq 3$, otherwise $p/q = [q] = [q + 1, 1]$, and we are done. The condition $0 < p < (q/2)$ implies that

$$(*) \quad \text{either } a_1 > 2 \text{ or } a_1 a_2 < 0.$$

To each a_i is associated a “fan” F_{a_i} consisting of a_i simplices in $D(p/q)$, see Figure 5.3(a) and (b) for the fans F_4 and F_{-4} . The edges labeled e_1 are called initial edges, and the ones labeled e_2 are called terminal edges. The diagram $D(p/q)$ can be constructed by gluing the F_{a_i} together in such a way that the terminal edge of F_{a_i} is glued to the initial edge of $F_{a_{i+1}}$. Moreover, if $a_i a_{i+1} < 0$ then F_{a_i} and $F_{a_{i+1}}$ have one edge in common, and if $a_i a_{i+1} > 0$ then they have a 2-simplex in common. See Figure 5.3(c) for the diagram of $[2, -2, -4, 2]$.

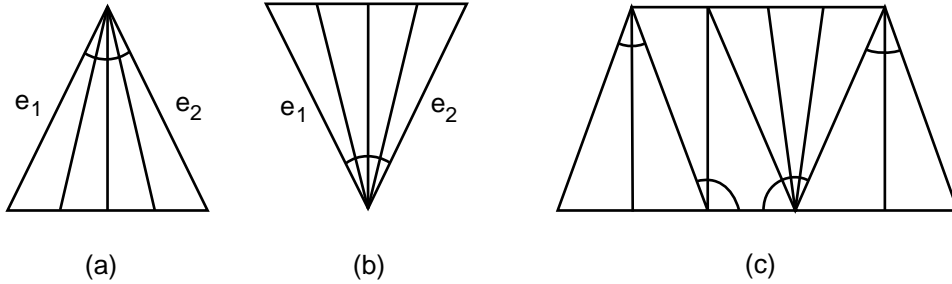

Figure 5.3

Note that a vertex on initial and terminal edges of F_{a_i} always has parity o/e or e/o . We use $*$ to indicate vertices with parity o/o .

If $a_i a_{i+1} < 0$, there is a channel in $F_{a_i} \cup F_{a_{i+1}}$ which starts and ends with boundary edges of $D(p/q)$, see Figure 5.4(a) for the channel in $F_2 \cup F_{-2}$. If $a_i a_{i+1} > 0$ and $a_i > 2$, there is a channel which starts with a boundary edge and ends with

an interior edge, but its union with a boundary edge of $D(p/q)$ is an allowable path, see Figure 5.4(b) for the path in $F_4 \cup F_2$.

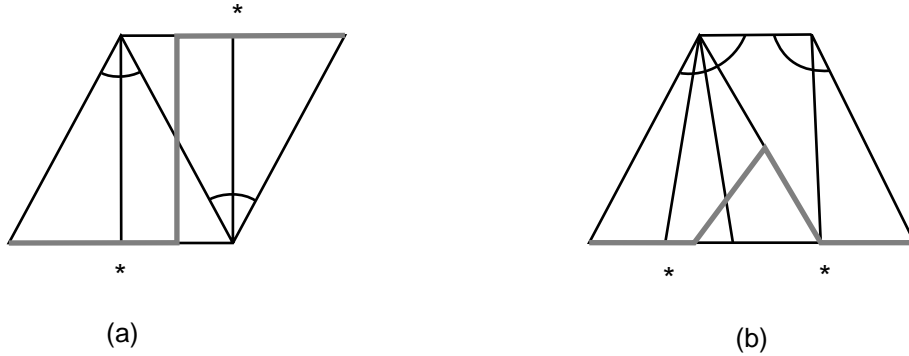

Figure 5.4

We call i a channel index for $[a_1, \dots, a_n]$ if either $a_i a_{i+1} < 0$ or $a_i a_{i+1} > 4$.

Claim. *If there are two channel indices for $[a_1, \dots, a_n]$, then $D(p/q)$ has an allowable path from $1/0$ to p/q with two channels.*

The idea is to join the channels given above with some boundary edges to form the required path. But we have to be careful, for example, there are no such paths for $[2, 4, 2]$. (However, condition (*) above excludes this from the set of p/q we are considering.) We prove the claim case by case. Assume that i and j are channel indices, and $i < j$.

CASE 1: *Both $a_i a_{i+1}$ and $a_j a_{j+1}$ are negative.*

We may choose i and j to be the first two such indices. Then $a_i > 0$, and $a_j < 0$. The channel for i starts with a bottom edge and ends with a top edge of $D(p/q)$, while the channel for j starts with a top edge and ends with a bottom edge, so they can be connected by boundary edges of $D(p/q)$ to become an allowable path. See Figure 5.5 for the case $p/q = [4, -2, -4, -2, 2]$. Note that this works even if $j = i + 1$.

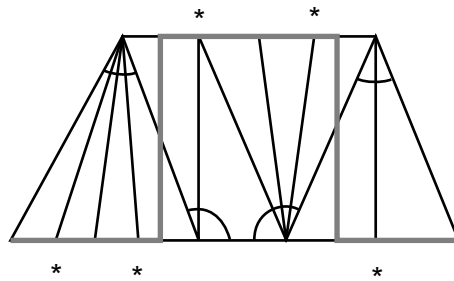

Figure 5.5

CASE 2. *$a_i a_{i+1} > 4$, and $a_j a_{j+1} < 0$.*

By Case 1 we may assume that a_i, a_{i+1} and a_j have the same sign. Then the path constructed above in $F_{a_i} \cup F_{a_{i+1}}$ start and end with bottom edges, and the channel in $F_{a_j} \cup F_{a_{j+1}}$ starts with bottom edge. So they can be joined with boundary edges

of $D(p/q)$ to form an allowable path from $1/0$ to p/q . See Figure 5.6 for the paths in the diagrams of $[2, 4, -2]$ and $[4, 2, -2]$.

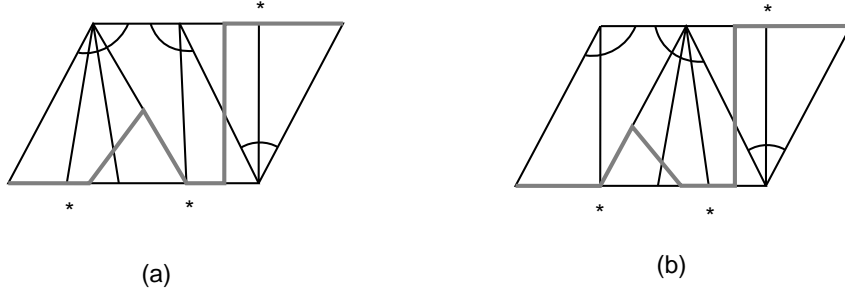

Figure 5.6

CASE 3. $a_i a_{i+1} < 0$, and $a_j a_{j+1} > 4$.

The proof is similar to that of Case 2.

CASE 4. $a_i a_{i+1} > 4$, and $a_j a_{j+1} > 4$.

By the above cases we may assume that all a_k are positive. Since we have assumed that either $a_1 > 2$ or $a_1 a_2 < 0$, we may further assume that $i = 1$, and $a_1 > 2$. The channels in $F_{a_i} \cup F_{a_{i+1}}$ and $F_{a_j} \cup F_{a_{j+1}}$ starts and ends on bottom edges of $D(p/q)$, so they can be joined by bottom edges of $D(p/q)$ to form the required allowable path. This can be done even if $j = i + 1$. See Figure 5.7 for the cases of $[4, 4, 2]$ and $[4, 2, 4]$.

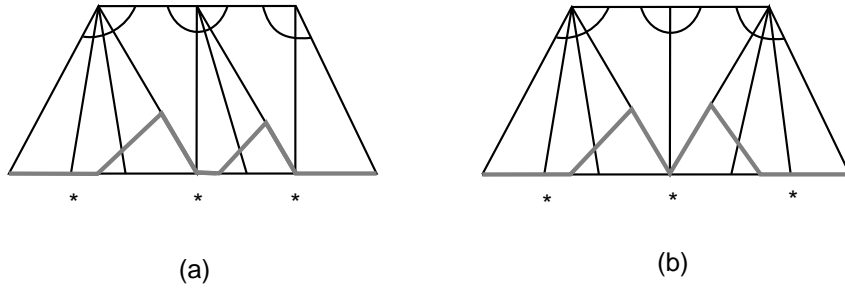

Figure 5.7

This completes the proof of the claim. The lemma is proved unless there is only one channel index for $[a_1, \dots, a_n]$. Condition (*) above says that 1 is a channel index. Therefore $[a_1, \dots, a_n]$ is either $[a_1, 2, \dots, 2]$ or $[a_1, -2, \dots, -2]$. One can check that in the first case $p/q = [a_1 - 1, n]$, and in the second case $p/q = [a_1 + 1, n]$. This completes the proof of Lemma 5.4. \square

Proof of Theorem 5.1. The “only if” direction follows from Lemma 5.3 and Lemma 5.4, noticing that if q is even and $p/q = [r, s]$ then r and s must be odd numbers. So we need only show that if $p/q \equiv [2t_1 + 1, 2t_2 + 1]$ then L admits a complete surgery producing a non-laminar manifolds. Without loss of generality we may assume that $t_1 > 0$.

The link $L = l_1 \cup l_2$ can be drawn as in Figure 5.8(a), where $t_1 = t_2 = 3$. Let $t = t_1 - t_2 + 1$. Let α be a curve on $\partial N(l_2)$ representing $tm + l$, where m, l are the meridian and longitude of l_2 . Denote by M the manifold obtained from S^3 by

t surgery on l_2 . Thus α bounds a disk in the Dehn filled solid torus, so if l'_1 is a band sum of l_1 and α , then l'_1 is isotopic to l_1 in M . See Figure 5.8(b). Note that l'_1 is a $(2, u)$ cable of a knot K on $\partial N(l_2)$, for some u , so the surgery on l'_1 along the cabling slope produces a manifold containing a lens space summand. The combination of these two steps yields a complete surgery on L which has a lens space summand, and hence is non-laminar by [GO]. \square

Remark 5.5. Surgeries on torus links are easy to understand. Most of them are Seifert fibered spaces. The exceptional ones are reducible, containing a lens space summand.

If $p/q = [r, s]$, $r, s \neq \pm 1$, then there is an allowable path in $D(p/q)$ with one channel. Let $M(\gamma_1, \gamma_2)$ be the manifold obtained from S^3 by γ_i surgery on l_i . By the argument in Lemma 5.3, the corresponding branched surface has one cusp for each component of L . Therefore if γ_i are non-integral slopes on $\partial N(l_i)$, then $M(\gamma_1, \gamma_2)$ is laminar. It is not known how many $M(\gamma_1, \gamma_2)$ are laminar if at least one of the γ_i is an integral slope.

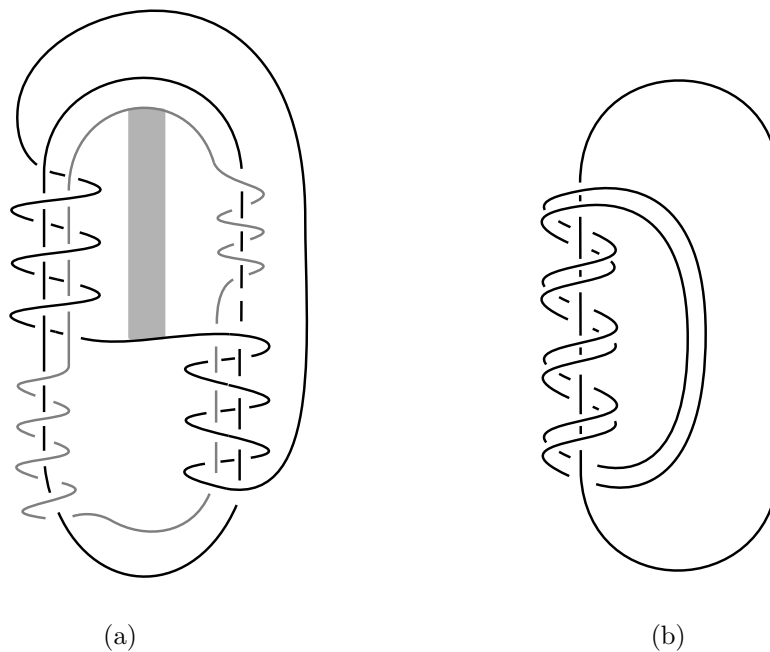

Figure 5.8

REFERENCES

[BW] M. Brittenham and Y-Q. Wu, *The classification of Dehn surgeries on 2-bridge knots*, preprint.
 [BS] F. Bonahon and L. Siebenmann, *Geometric splittings of knots, and Conway's algebraic knots*, preprint.
 [CGLS] M. Culler, C. Gordon, J. Luecke and P. Shalen, *Dehn surgery on knots*, *Annals of Math.* **125** (1987), 237–300.

- [De1] C. Delman, *Essential laminations and Dehn surgery on 2-bridge knots*, *Topology and its Appl.* **63** (1995), 201–221.
- [De2] ———, *Constructing essential laminations which survive all Dehn surgeries*, preprint.
- [Fl] W. Floyd, *Incompressible surfaces in 3-manifolds: The space of boundary curves*, *Low-dimensional topology and Kleinian groups*, *London Math. Soc. LN.* 112, 1986, pp. 131–143.
- [Ga] D. Gabai, *Eight problems in the geometric theory of foliations and laminations on 3-manifolds*, *Proceedings of Georgia Topology Conference, Part II, 1997*, pp. 1–33.
- [Ga2] ———, *Genera of the arborescent links*, *Mem. Amer. Math. Soc.* **339** (1986), 1–98.
- [GO] D. Gabai and U. Oertel, *Essential laminations in 3-manifolds*, *Ann. Math.* **130** (1989), 41–73.
- [Gor] C. Gordon, *Dehn surgery on knots*, *Proceedings of the International Congress of Mathematicians, Kyoto (1990)*, 631–642.
- [GL] C. Gordon and J. Luecke, *Knots are determined by their complements*, *Jour. Amer. Math. Soc.* **2** (1989), 371–415.
- [HT] A. Hatcher and W. Thurston, *Incompressible surfaces in 2-bridge knot complements*, *Invent. Math.* **79** (1985), 225–246.
- [He] J. Hempel, *3-manifolds*, *Ann. Math. Studies* **86**, Princeton Univ. Press, 1976.
- [Oe] U. Oertel, *Closed incompressible surfaces in complements of star links*, *Pacific J. Math.* **111** (1984), 209–230.
- [Sch] M. Scharlemann, *Unlinking via simultaneous crossing changes*, *Trans. Amer. Math. Soc.* **336** (1993), 855–868.
- [St] E. Starr, *Curves in handlebodies*, Thesis UC Berkeley (1992).
- [Th] W. Thurston, *Three dimensional manifolds, Kleinian groups and hyperbolic geometry*, *Bull. Amer. Math. Soc.* **6** (1982), 357–381.
- [Wu3] Y-Q. Wu, *The classification of nonsimple algebraic tangles*, *Math. Ann.* **304** (1996), 457–480.
- [Wu2] ———, *Dehn surgery on arborescent knots*, *J. Diff. Geo.* **43** (1996), 171–197.
- [Wu3] ———, *Imcompressibility of surfaces in surgered 3-manifolds*, *Topology* **31** (1992), 271–279.

DEPARTMENT OF MATHEMATICS, UNIVERSITY OF IOWA, IOWA CITY, IA 52242
E-mail address: wu@math.uiowa.edu